

Cree® PLCC4 2-in-1 SMD LED

CLM4S-DKW

Data Sheet

SMD LEDs are packaged in the industry-standard package. These LEDs have high-reliability performance and are designed to work under a wide range of environmental conditions. This high-reliability feature makes them ideally suited to be used under architectural lighting application conditions.

Their wide viewing angle make these LEDs ideally suited for channel letters or architectural lighting applications. The flat-top emitting surface makes it easy for these LEDs to mate with light pipes.



FEATURES

- Size (mm): 3.2 x 2.8
- Dominant Wavelength (nm):
 - » Red (620-628)
 - » Green (520-540)
- Luminous Intensity (mcd)
 - » Red (140-355)
 - » Green (280-900)
- Lead-Free
- RoHS-Compliant

APPLICATIONS

- Full-Color Video Screen
- Decorative Lighting
- Amusement



Absolute Maximum Ratings ($T_A = 25^\circ\text{C}$)

Items	Symbol	Absolute Maximum Rating		Unit
		R	G	
Forward Current ^{Note 1}	I_F	50	25	mA
Peak Forward Current ^{Note 2}	I_{FP}	200	100	mA
Reverse Voltage	V_R	5	5	V
Power Dissipation	P_D	125	100	mW
Operation Temperature	T_{opr}	-40 ~ +100		$^\circ\text{C}$
Storage Temperature	T_{stg}	-40 ~ +100		$^\circ\text{C}$
Junction Temperature	T_J	110	110	$^\circ\text{C}$
Junction/ambient	R_{THJA}	450	400	$^\circ\text{C}/\text{W}$
Junction/solder point	R_{THJS}	300	280	$^\circ\text{C}/\text{W}$

Note:

1. Single-color light.
2. Pulse width ≤ 0.1 msec, duty $\leq 1/10$.

Typical Electrical & Optical Characteristics ($T_A = 25^\circ\text{C}$)

Characteristics	Condition	Symbol	Values		Unit
			R	G	
Wavelength at peak emission	$I_F = 20$ mA	λ_{PEAK}	624	527	nm
Dominant Wavelength	$I_F = 20$ mA	λ_{DOM}	620~628	520~540	nm
Spectral bandwidth at 50% I_{REL} max	$I_F = 20$ mA	$\Delta \lambda$	23	38	nm
Viewing Angle at 50% I_V	$I_F = 20$ mA	$2\theta_{1/2}$	120	120	deg
Forward Voltage	$I_F = 20$ mA	$V_{F(avg)}$	2.0	3.4	V
		$V_{F(max)}$	2.5	4.0	V
Luminous Intensity	$I_F = 20$ mA	$I_{V(min)}$	140	280	mcd
		$I_{V(avg)}$	180	450	mcd
Reverse Current (max)	$V_R = 5$ V	I_R	10	10	μA



Intensity Bin Limit ($I_f = 20 \text{ mA}$)

Red

Bin Code	Min. (mcd)	Max. (mcd)
D	140	180
E	180	224
F	224	280
G	280	355

Green

Bin Code	Min. (mcd)	Max. (mcd)
G	280	355
H	355	450
J	450	560
K	560	710
M	710	900

Tolerance of measurement of luminous intensity is $\pm 10\%$.

Color Bin Limit ($I_f = 20 \text{ mA}$)

Red

Bin Code	Min. (nm)	Max. (nm)
RD	620	628

Green

Bin Code	Min. (nm)	Max. (nm)
GD	520	540

Tolerance of measurement of dominant wavelength is $\pm 1 \text{ nm}$.



Order Code Table*

Kit Number	Color	Luminous Intensity (mcd)		Dominant Wavelength (nm)				Package
		Min.	Max.	Color Bin	Min. (nm)	Color Bin	Max. (nm)	
CLM4S-DKW-CDGGMDDDD3	Red	140	355	RD	620	RD	628	Reel
	Green	280	900	GD	520	GD	540	Reel

Notes:

- The above kit numbers represent the order codes which include multiple intensity-bin and color-bin codes. Only one intensity-bin code and one color-bin code will be shipped on each reel. Single intensity-bin codes and single color-bin code will be orderable in certain quantities.
- Please refer to the "Cree LED Lamp Reliability Test Standards" document for reliability test conditions.
- Please refer to the "Cree LED Lamp Soldering & Handling" document for information about how to use this LED product safely.

Graphs

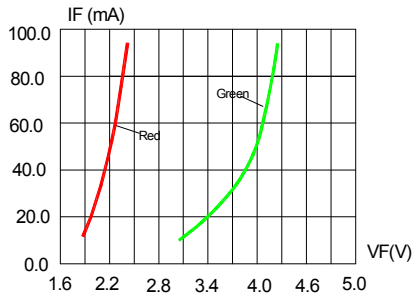

FIG.1 FORWARD CURRENT VS. FORWARD VOLTAGE.

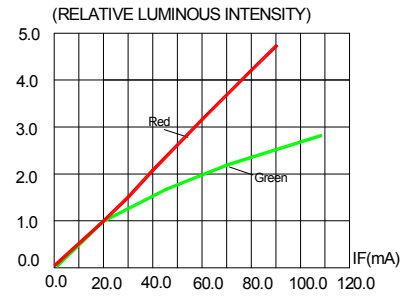

FIG.2 RELATIVE LUMINOUS INTENSITY VS. FORWARD CURRENT

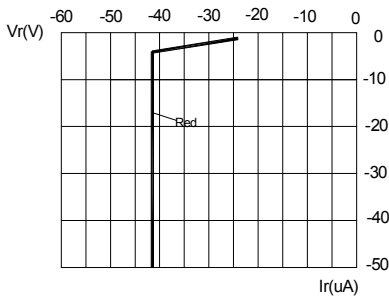

FIG.3a RED REVERSE CURRENT VS. REVERSE VOLTAGE.

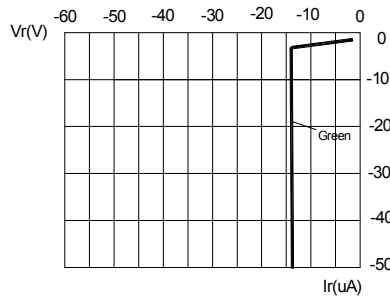

FIG.3b GREEN REVERSE CURRENT VS. REVERSE VOLTAGE.

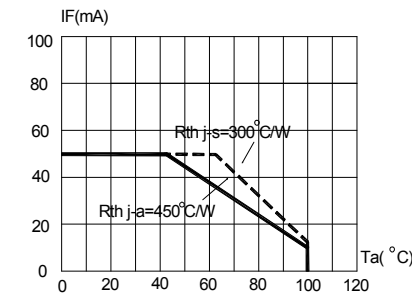

FIG.4a RED MAXIMUM FORWARD DC CURRENT VS AMBIENT TEMPERATURE ($T_{jmax}=110^{\circ}C$)

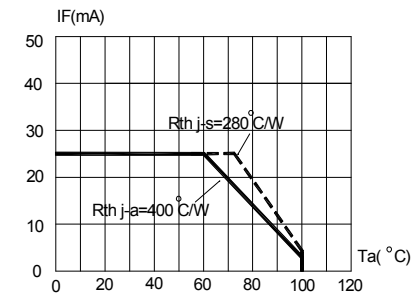

FIG.4b GREEN MAXIMUM FORWARD DC CURRENT VS AMBIENT TEMPERATURE ($T_{jmax}=110^{\circ}C$)

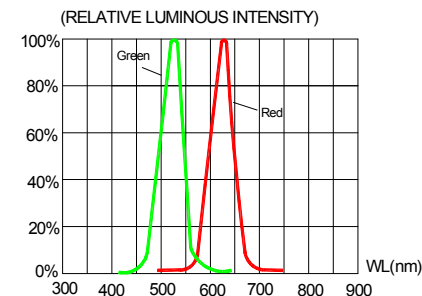

FIG.5 RELATIVE LUMINOUS INTENSITY VS. WAVELENGTH.

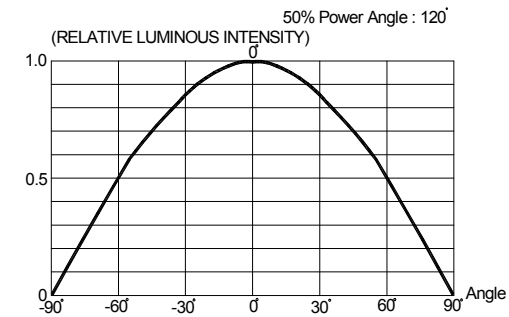
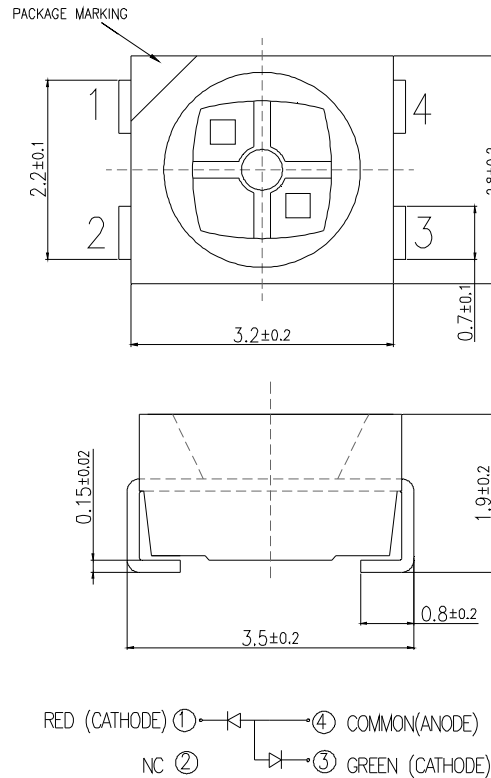

FIG.6 FAR FIELD PATTERN

The above data are collected from statistical figures that do not necessarily correspond to the actual parameters of each single LED. Hence, these data will be changed without further notice.

Mechanical Dimensions

All dimensions are in mm.



Notes

RoHS Compliance

The levels of environmentally sensitive, persistent biologically toxic (PBT), persistent organic pollutants (POP), or otherwise restricted materials in this product are below the maximum concentration values (also referred to as the threshold limits) permitted for such substances, or are used in an exempted application, in accordance with EU Directive 2002/95/EC on the restriction of the use of certain hazardous substances in electrical and electronic equipment (RoHS), as amended through April 21, 2006.

Vision Advisory Claim

Users should be cautioned not to stare at the light of this LED product. The bright light can damage the eye.



Kit Number System

Cree LED lamps are tested and sorted into performance bins. A bin is specified by ranges of color, forward voltage, and brightness. Sorted LEDs are packaged for shipping in various convenient options. Please refer to the "Cree LED Lamp Packaging Standard" document for more information about shipping and packaging options.

Cree LEDs are sold by order codes in combinations of bins called kits. Order codes are configured in the following manner:

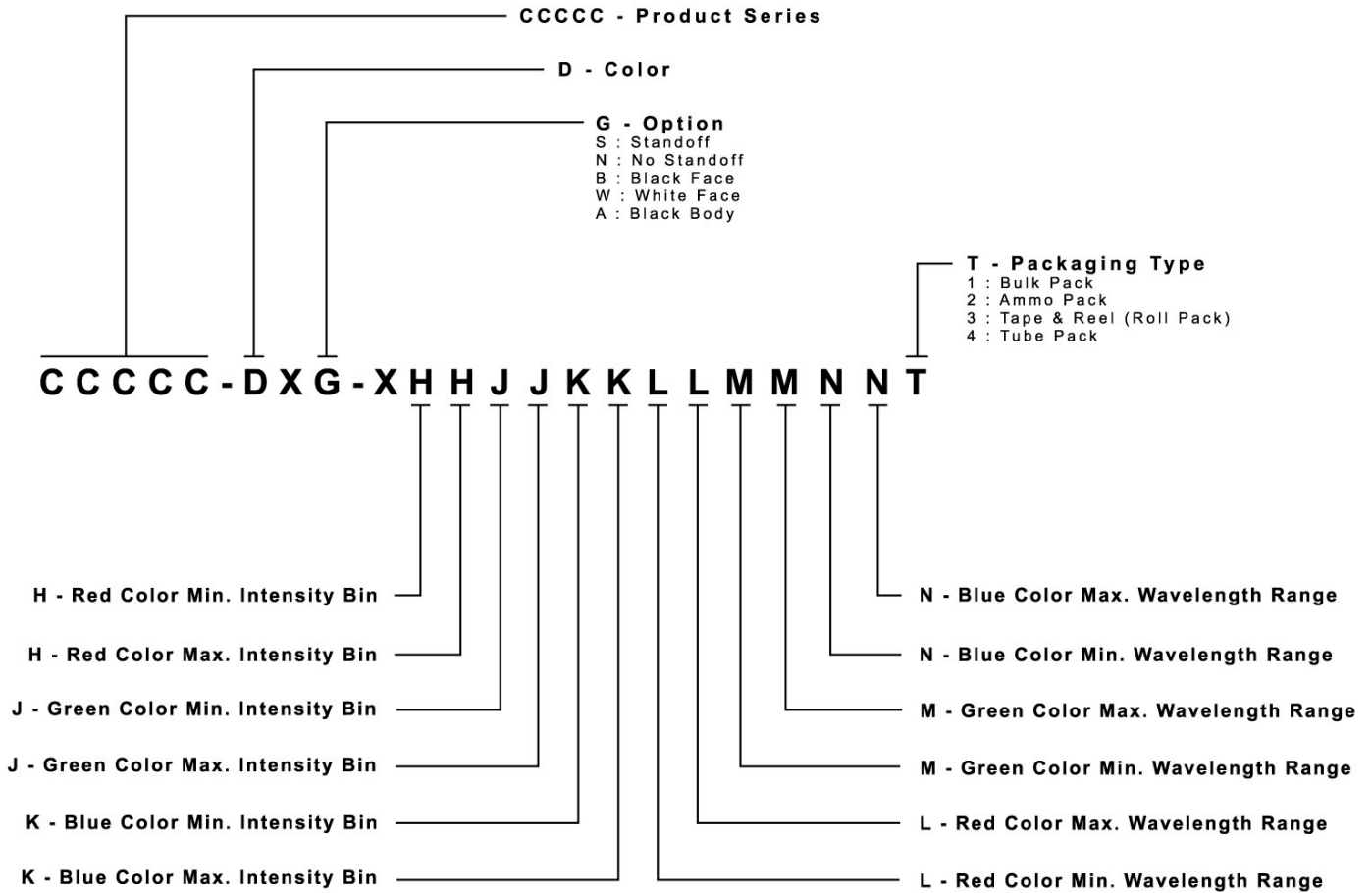

Package

- The boxes are not water-resistant, and they must be kept away from water and moisture.
- The LEDs are packed in cardboard boxes after packaging in normal or anti-electrostatic bags.
- Cardboard boxes will be used to protect the LEDs from mechanical shocks during transportation.
- The reel pack is applied in SMD LED.
- Max 2000 pcs per reel.

